

KOMATSU[®]

PC500LC-10R

HYDRAULIC EXCAVATOR

PC500LC



Photos may include optional equipment.

HORSEPOWER

Gross: 270 kW 362 HP/1900 min⁻¹
Net: 269 kW 360 HP/1900 min⁻¹

OPERATING WEIGHT

49400 - 51300 kg

BUCKET CAPACITY

2.50 - 4.00 m³

WALK-AROUND

*Gives You the Higher Returns,
with Peace of Mind.*

PC500LC-10R



HORSEPOWER

Gross: 270 kW 362 HP/1900 min⁻¹
Net: 269 kW 360 HP/1900 min⁻¹

OPERATING WEIGHT

49400 - 51300 kg

BUCKET CAPACITY

2.50 - 4.00 m³



Lower Fuel Consumption

- **Reduction of fuel consumption by 11%** (Compared to the PC450-8R)
- **Advanced management system of variable engine speed matching control**
- **Fan clutch system**
- **Reduction of hydraulic piping loss**

Higher Productivity

- **Larger bucket capacity**
- **Powerful digging operation**

Durability & Reliability

- **Enhanced work equipment**
- **Newly largersized undercarriage**
- **Heavy-duty main frame and rigidity swing circle**
- **Improved engine reliability**

Lower Maintenance Cost

- **Less maintenance time with new features**
- **Detection system to prevent failure of main components**
- **More visible maintenance information on the monitor screen**

Safety & Comfort

- **Large comfortable cab**
- **Rear view monitor system (Optional)**

Information & Communication Technology (ICT) & KOMTRAX

- **Large multi-lingual high resolution Liquid Crystal Display (LCD) monitor**
- **Equipment Management Monitoring System**
- **KOMTRAX**

LOWER FUEL CONSUMPTION

KOMATSU NEW ENGINE TECHNOLOGIES

Low Fuel Consumption Technology

Engine management is enhanced. The variable speed matching of the engine, hydraulic pump and a viscous fan clutch guarantee efficiency and precision. Through the in-house development and production of main components, Komatsu has achieved great advancements in technology, providing high levels of performance and efficiency in virtually all applications.

Fuel consumption

Reduced by **11%**

vs PC450-8R
Based on typical work pattern collected via KOMTRAX. This fuel consumption data is the result that compared actual measured value by using the prototype machine.

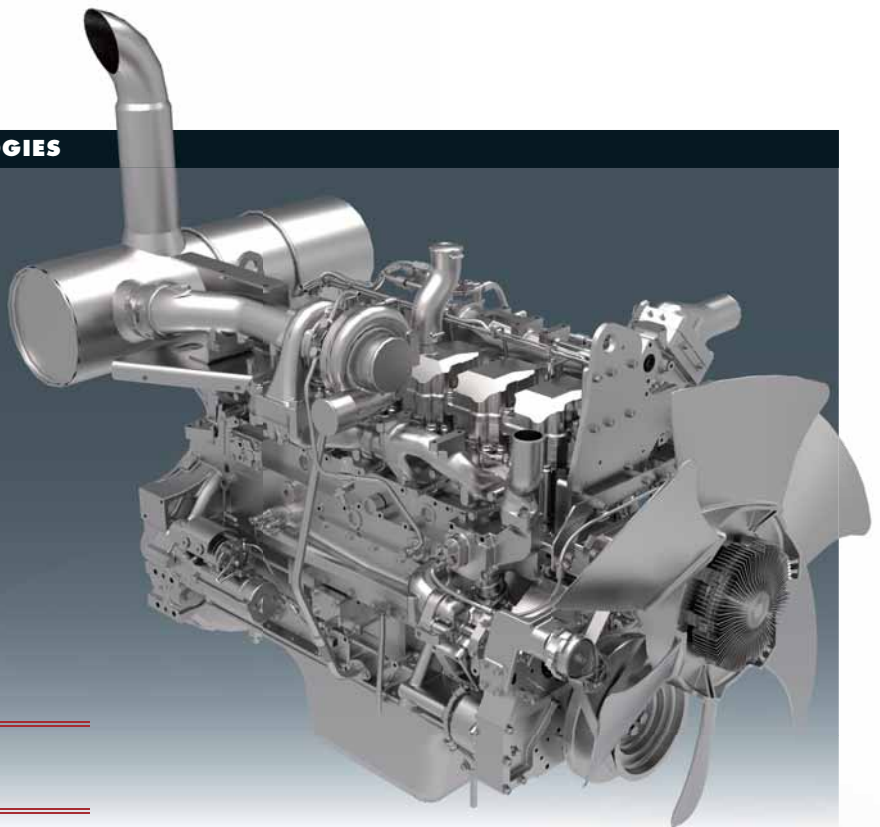

Komatsu SAA6D125E-5 engine
EU Stage 2 emission equivalent.
(CG image)

Improvement of engine combustion efficiency

By optimizing the fuel injection control, the engine combustion efficiency is improved. This technology achieved both high power output and low fuel consumption.

Reduction of hydraulic pressure loss

The internal shape of the control valves, piping diameter and fitting shape have been thoroughly revised. With this improvement, hydraulic loss is reduced more than ever. It contributes to low fuel consumption.

Reduced fan speed and fan drive loss

A speed controlled viscous fan clutch and large diameter fan improves engine efficiency and reduces engine power requirements when operating in cooler temperatures.



Enhanced engine-pump matching control

Large displacement hydraulic main pumps provide high flow output at low engine RPM. Furthermore, by building in optimum matching of the engine and pumps, it keeps high operability and workability. This technology achieved a large production and low fuel consumption.

Assists Energy-saving Operations

ECO gauge

Equipped with the ECO gauge that can be recognized at a glance on the right of the multi-function color monitor for environment-friendly energy-saving operations. Allows focus on operation in the green range with reduced CO₂ emissions and efficient fuel consumption.

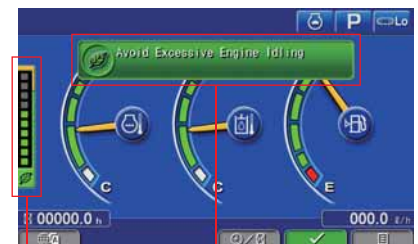

ECO gauge

Idling caution

Idling caution

To prevent unnecessary fuel consumption, an idling caution is displayed on the monitor, if the engine idles for 5 minutes or more.

Auto idle stop function

When the engine has been idling for certain time, the engine stops automatically to reduce unnecessary fuel consumption and exhaust emissions. The duration before the engine shutdown can be easily programmed.

Fuel Saving Support Functions

Just select a working mode that suits your purpose

In P mode, LARGE PRODUCTION is implemented. In E mode, LOW FUEL CONSUMPTION is implemented. E mode can be adjusted widely from E0 to E3 mode, and it adapts flexibly to customer's demands. Komatsu tuned each working mode precisely, ensuring high operability and workability. Just by selecting the working mode, it provides the best performance in demanding applications.

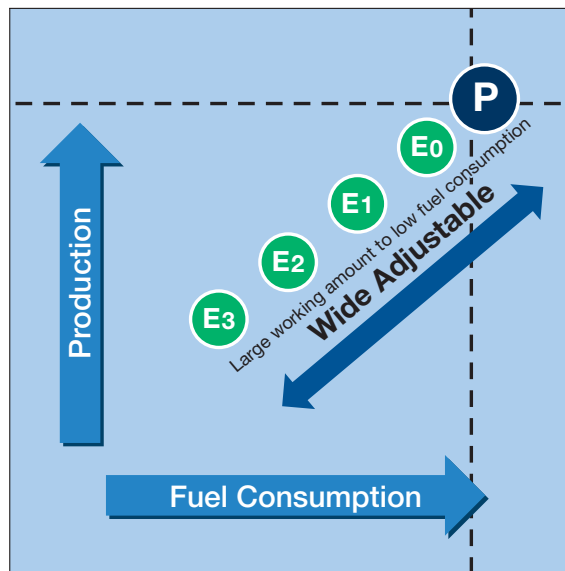

P (Power mode):

Maximum production
Fast cycle time

E (Economy mode):

Better fuel consumption

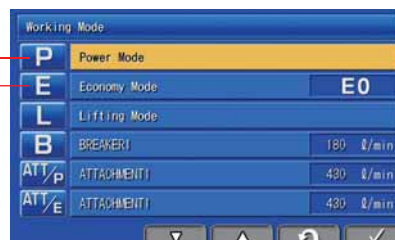

Easy selectable E mode

Compared with the conventional model, E0 to E3 can be easily selected on the monitor.

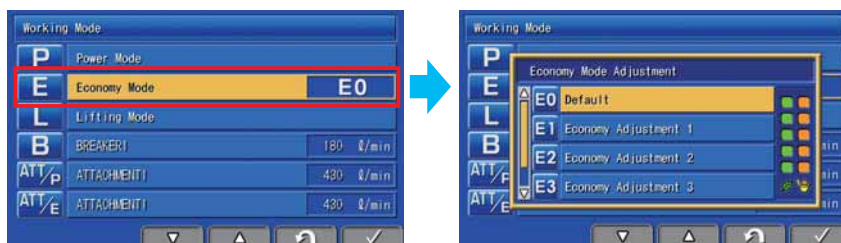

In addition to the above modes there are also the following modes. Please select the appropriate mode according to the application.

Working Mode	Application	Advantages
L	Lifting mode	<ul style="list-style-type: none"> Suitable attachment speed Lifting capacity is increased 7% by raising hydraulic pressure.
B	Breaker mode	<ul style="list-style-type: none"> Optimum engine rpm, hydraulic flow
ATT/P	Attachment Power mode	<ul style="list-style-type: none"> Optimum engine rpm, hydraulic flow, 2way Power mode
ATT/E	Attachment Economy mode	<ul style="list-style-type: none"> Optimum engine rpm, hydraulic flow, 2way Economy mode

Two-mode Setting for Boom

Smooth mode provides easy operation for gathering blasted rock or scraping down operation. When maximum digging force is needed, switch to Power mode for more effective excavating.

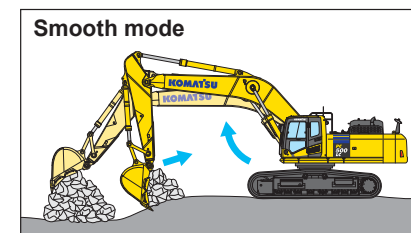

Boom floats upward, reducing lifting of machine front. This facilitates gathering blasted rock and scraping down operations.

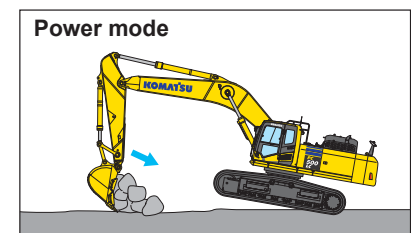

Boom pushing force is increased, ditch digging and box digging operation on hard ground are improved.

Smooth Loading Operation

Two return hoses improve hydraulic performance. In the arm out function, a portion of the oil is returned directly to the tank providing smooth operation.

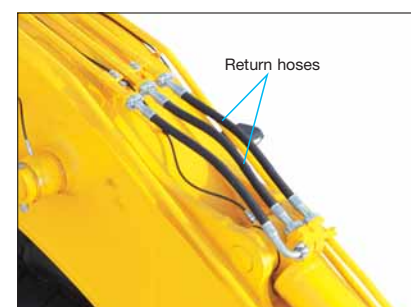

HIGHER PRODUCTIVITY



Increase Productivity

Productivity with t/L is improved by large bucket capacity and upgrading basic performance. It improves productivity and economical performance.

Fuel efficiency (t/L)

21% increase

vs PC450-8R
P mode (90° swing and loading onto truck)

Large capacity buckets

Bucket selection up to 3.10 m³ are available. It can be matched for various applications.

Bucket capacity

2.50 m³ & 3.10 m³

(Allowed material density: 1.8 t/m³)

(Allowed material density: 1.5 t/m³)

7060 mm boom and 3380 mm arm

2.50 m³ HD bucket & 3.10 m³ GP bucket

By optimizing the shape of the side edge, it increases the penetration force.

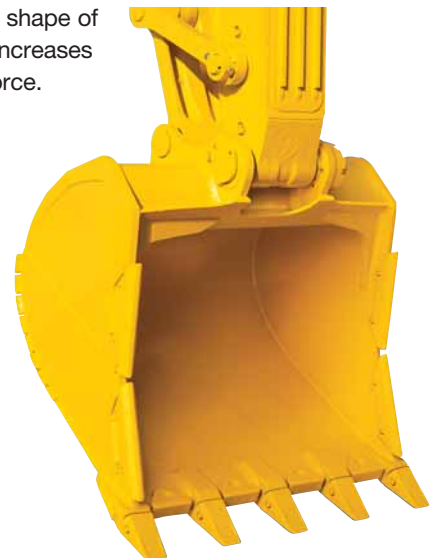

Powerful digging operation

Digging in P mode became powerful by improving hydraulic control. When more power is needed, the engine output is powered up by the one-touch power max. function (See next article), and you can dig stronger. Increasing engine power achieved high performance.

Engine horsepower Compared to the PC450-8R

5% up (269 kW ◀ 257 kW)

Bucket digging force Compared to the PC450-8R

9% up (303 kN ◀ 277 kN)

One-touch power max. function

Digging force increase for 8.5 seconds of operation when press the left knob switch which is called the one-touch power max. switch.

One-touch
power max. switch



Maximum arm crowd force (ISO 6015)

7% up (235 kN [24.0 t] ◀ 219 kN [22.3 t])
(With power max. function)

Maximum bucket digging force (ISO 6015)

7% up (303 kN [30.9 t] ◀ 283 kN [28.9 t])
(With power max. function)

Measured with power max. function, 3380 mm arm and ISO 6015



DURABILITY & RELIABILITY

High Durability for 50-ton Class Excavator

Whole structure of PC500LC-10R is completely renewed on the assumption of severer jobsites. Durability and reliability are greatly improved.



New reinforced working equipment with excellent durability and reliability

Remodeled new reinforced working equipment to adapt larger size bucket. It is much suitable for severe condition working. The newly designed working equipment achieve high durability and reliability with high performance.

Optimizes shape of casting

The shapes of the cast parts exposed to high loads are optimized for higher durability and reliability.



Wide boom and arm

Rigidity is increased by increasing the working equipment size. The newly developed working equipment resists twisting and bending well.

* It is not interchangeable to PC450-8R, due to upsize width of working equipment.

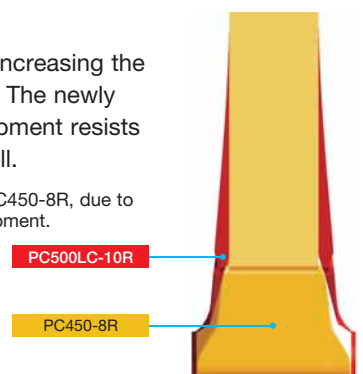

New reinforced undercarriage

Newly largersized undercarriage adopts as standard. Durability and reliability are significantly improved by reinforcing and increasing the size of all components.



Improve Engine Reliability

Total reliability for engine is improved by new water cooled turbo and new injector. It is more reliable than current model.

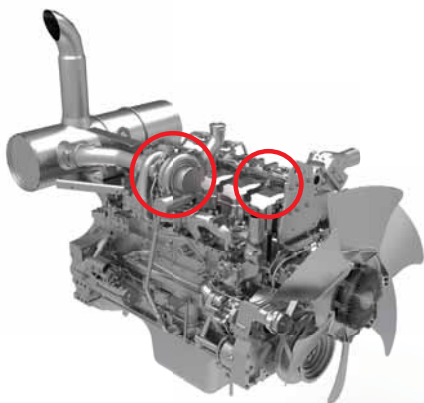

O-ring Face Seal

The hydraulic hose seal method has been changed from a conventional taper seal to an O-ring seal. This provides improved sealing performance.



Metal Guard Rings

Metal guard rings protect all the hydraulic cylinders and improve reliability.

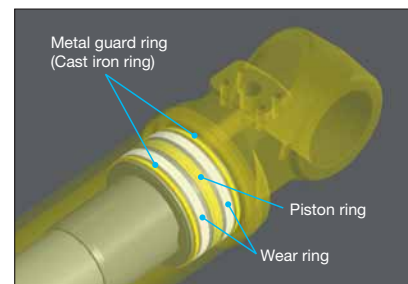

Fuel Pre-filter

(With water separator)

Removes water and contaminants from fuel to enhance the fuel system reliability.



Shield Connectors

Shield connectors seal tight and have higher reliability.

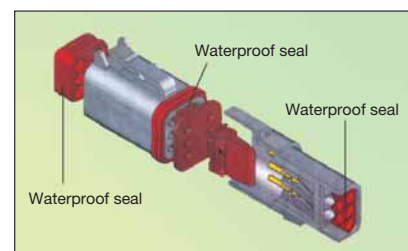

LOWER MAINTENANCE COST

**Maintenance is Also Part of the Operating Cost.
Komatsu Pursued Reduction of Maintenance Time and Cost.**

Centralized filters

It is easy to access all filters. All filter cartridges are located at pump room. It can reduce time of periodical maintenance.



PC500LC-10R

Easy cleaning cooling unit

Cleanability of the cooling unit has been improved. It is effective in the field of dusty site.

- Improvement core cleanability by enabling openable engine hood side cover
- Making oil cooler a single piece from 3 pieces, no more space accumulating dust



Easy oil sampling (Optional)

Easy oil sampling ports are added. It is important to get sample that is agitated properly. Using this equipment will help accurate analysis.



Auto tension fan belt

Belt tension for cooling fan and compressor and alternator are adjusted automatically.

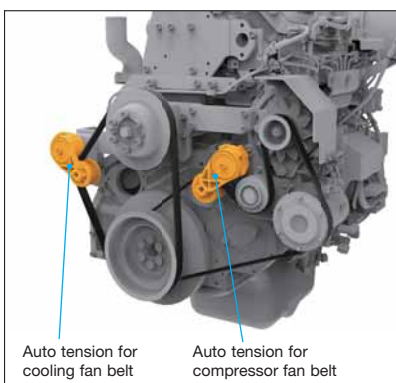

Easy maintenance time management

The monitor informs replacement time of oil and filters on the LCD when the replacement interval is reached.

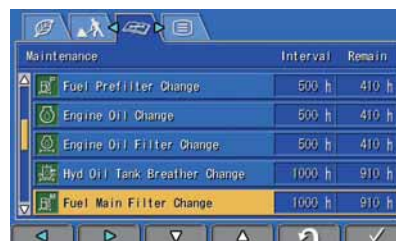

Easy to know maintenance time when using breaker

In addition to the above functions, it monitors the breaker usage time. Since the replacement time will be changed depending on the breaker usage time, monitor can notify the optimum replacement time.



Detect abnormality of hydraulic circuit
Clogging sensor for hydraulic oil as standard

When the hydraulic oil filter is clogged, the caution message pops up on the monitor to notify replacing the filter. It is possible to suppress repair cost due to breakdown.

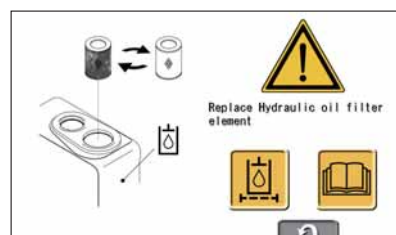

Clogging hydraulic oil filter caution

Clogging sensor for breaker line (Optional)

Battery disconnect switch

A battery disconnect switch allows a technician to disconnect the power supply and lock out before servicing or maintenance the machine. Also, minimize discharge of the battery during long-term non operation. System operating lamp tells the timing of disconnect the switch to prevent controller failures.



Pre-cleaner for dusty condition

Even in dusty places, by installing pre-cleaner coupled with the large air cleaner, the frequency of cleaning the air cleaner will be reduced.

Other Features

Easy to check level of hydraulic oil

Electric priming pump

Blow-by pressure detection

SAFETY & COMFORT



Ensuring Operator's Comfort, It Contributes to Increase Safety and Productivity.

Wide newly-designed cab

Newly-designed wide spacious cab includes seat with reclining back-rest. The seat height and longitudinal inclination are easily adjusted using a pull-up lever. You can set the appropriate operational posture of armrest together with the console. Reclining the seat further enables you to place it into the fully flat state with the headrest attached.

New adjustable armrest without tools

The height of the armrest is quickly and easily adjusted without tools.



Pressurized cab

Pressurizing inside the cab to minimize the dust entering from outside. It can keep cab clean.

Low cab noise

With overwhelming low noise, you can operate without stress. Ambient noise is also reduced, reducing the stress of surrounding workers.

Low vibration with cab damper mounting

The cab damper mounting combined with high rigidity deck aids vibration reduction at operator seat.

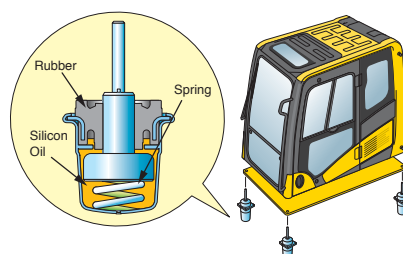

Suspension seat

Suspension seat with weight adjustment function as standard equipment. This seat can reduce fatigue even in operation for a long time.

Automatic air conditioner (A/C)

It adjusts automatically to a comfortable temperature throughout the year, even in hot and cold areas.

Sun roller blind

Prepared a roller blind which blocks strong sunlight. Reduce sunlight at any time of day.



Lock lever auto lock function

If the work equipment lever is not in the neutral position when the hydraulic lock lever is released, the equipment is automatically stopped. The auto stop state is shown on the monitor screen.



Lock lever

Locks the hydraulic pressure to prevent unintentional movement. Neutral start function allows machine to be started only in lock position.



Engine shutdown secondary switch

Engine stop switch added for emergency use.



Seat belt caution indicator



Hand rails prevent accidental fall-off



Large serrated steps



Rear view monitor system (Optional)

The operator can view the rear of the machine with a color monitor screen.



Rear view image on monitor

Fan guards

Fan guards are placed around fan drive.

Pump/engine room partition

Pump/engine room partition prevents oil from spraying onto the engine if a hydraulic hose should fail.



AUX

12 V power supply

Magazine box

Cool & hot box

Luggage box



LARGE HIGH RESOLUTION LCD MONITOR



Large Multi-lingual High Resolution LCD Monitor

A large user-friendly high resolution LCD color monitor enables safe, accurate and smooth work. Simple and easy to operate switches. Function keys facilitate multi-function operations. Displays data in 15 languages to globally support operators around the world.

Indicators

- | | |
|-----------------------------------|--------------------------|
| 1 Auto-decelerator | 6 Fuel gauge |
| 2 Working mode | 7 ECO gauge |
| 3 Travel speed | 8 Fuel consumption gauge |
| 4 Engine water temperature gauge | 9 Function switches menu |
| 5 Hydraulic oil temperature gauge | 10 Language select |

Basic operation switches

- | | |
|-------------------------|-----------------|
| 1 Auto-decelerator | 4 Buzzer cancel |
| 2 Working mode selector | 5 Wiper |
| 3 Traveling selector | 6 Window washer |

Supports Efficient Operation

The main screen displays advices for promoting energy-saving operations as needed. The operator can use the ECO guidance menu to check the operation records, ECO guidance records, average fuel consumption logs, etc.



ECO guidance



ECO guidance menu



ECO guidance records



Operation records



Average fuel consumption logs

Simplified Selection of Languages and New Languages added.

It supports 15 languages including newly added languages. Language selection has become extremely easy.



Equipment Management Monitoring System

Monitor function

Controller monitors engine oil level, coolant temperature, battery charge air clogging, etc. If the controller finds any abnormality, it is displayed on the LCD.

Maintenance function

The monitor informs replacement time of oil and filters on the LCD when the replacement interval is reached.

Trouble data memory function

Monitor stores abnormalities for effective troubleshooting.

KOMTRAX

The Komatsu remote monitoring and management technology provides insightful data about your equipment and fleet in user-friendly format.

Energy Saving Operation Report

KOMTRAX delivers the energy-saving operation report based on the operating information such as fuel consumption, load summary and idling time, which helps you efficiently run a business.



This report image is an example of hydraulic excavator

Equipment Management Support

Through the web application, a variety of search parameters are available to quickly find information about specific machines based on key factors. Moreover, KOMTRAX finds out machines with problems from your fleet and shows you through an optimal interface.

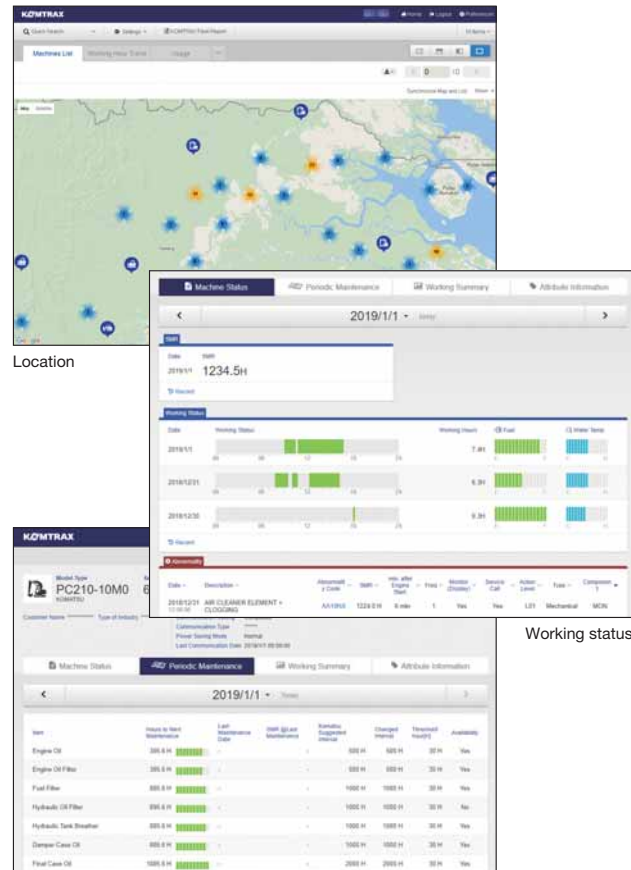

Location

Working status

Periodic maintenance

The report contents and data depend on the machine model.

Optimal Strategy for Efficient Work

The detailed information that KOMTRAX puts at your fingertips helps you manage your fleet conveniently on the web anytime, anywhere. It gives you the power to make better daily and long-term strategic decisions.



SPECIAL SPEC.

Attachment Spec.

Equips PC500LC-10R for breaker and crusher installation. Hydraulic flow rate can be regulated by setting breaker mode on monitor panel for breaker operation.



Pilot filter



Inline filter



Stop valve

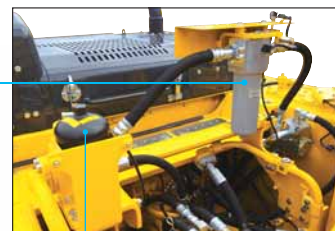

Additional filter for breaker with clogging sensor



Accumulator



SE Spec. (Optional)

Increased productivity by new SE boom and large capacity buckets. It improves the efficiency of loading to dump truck with large amount of loose material such as blasted rock.

Bucket capacity for 2.4 m SE arm

HD bucket

3.50 m³

Allowed material density:
1.8 t/m³

GP bucket

4.00 m³

Allowed material density:
1.5 t/m³

Bucket capacity for 2.9 m SE arm

HD bucket

3.00 m³

Allowed material density:
1.8 t/m³

GP bucket

3.70 m³

Allowed material density:
1.5 t/m³

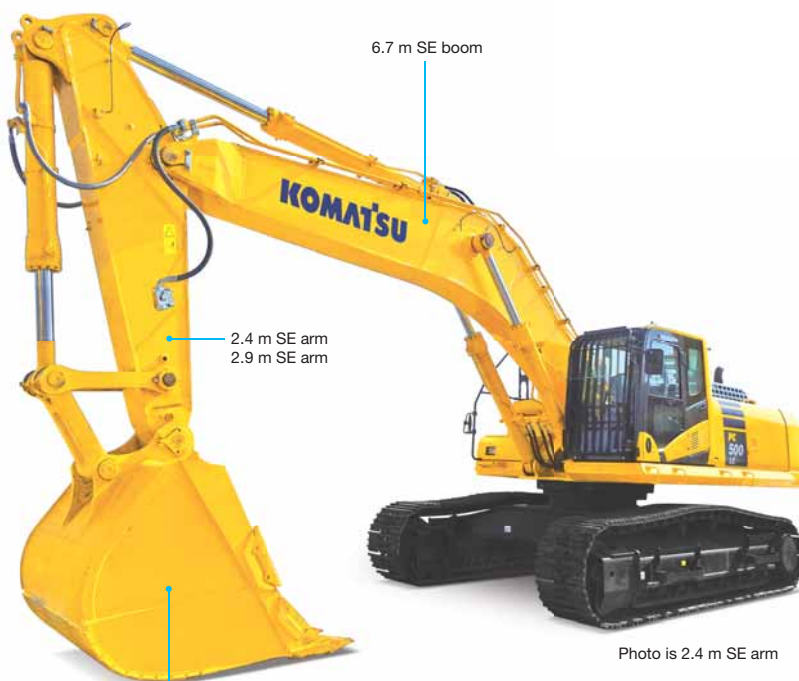

6.7 m SE boom

2.4 m SE arm
2.9 m SE arm

Large capacity bucket

Photo is 2.4 m SE arm

PC500LC-10R

OPTIONS

Cab front full height guard level 1 (ISO 10262)



Cab front full height guard level 2 (ISO 10262)



OPG top guard level 2 (ISO 10262)



Additional front lights
Rain visor



Additional handrail



Double grouser shoe



Fuel refill pump

BUCKET

Feature of Komatsu Bucket

The bucket affects most of the digging work and fuel consumption. Komatsu has line-up of various buckets so that you can choose a bucket suitable for your jobsite condition. You can also choose a bucket made by HENSLEY as one of the options. Please contact your dealer.

New Shape Bucket

Easy to Make Bucket Full and Good Penetration

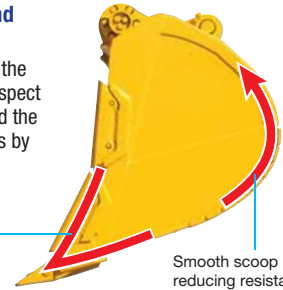

The angle to the deepest part of the bucket becomes smooth with respect to the direction of excavation and the penetration resistance decreases by new shape of side edge.

Sharp edge to increase penetration

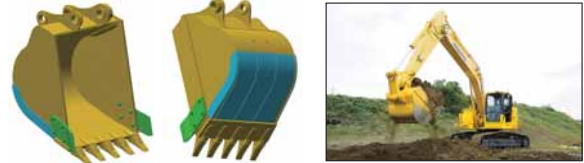
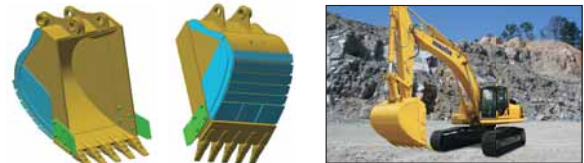

Smooth scoop by reducing resistance

Category and Feature

Category	Load / Wear / Soil (Application)	Image
Light Duty LD	Load Machine power remains low during the majority of the work. No impact load. Wear Material is not abrasive. Soil Dirt, loam and clay.	
General Purpose GP	Load Machine power is mostly medium, but occasionally high. Bucket movements are smooth with minor shock load. Bucket penetrates easily. Wear Material is lightly abrasive. Some sand may be medium abrasive. Soil Mostly loose sand, gravel and finely broken materials.	
Heavy Duty HD	Load Machine power is high during majority of the work. Medium, but continuous shock load. Wear Material is abrasive. Light scratch marks can be seen at the bucket. Soil Limestone, shot rock, compact mix of sand, gravel and clay.	
Extra Heavy Duty XHD	Load Machine power is high during most of the work, often at maximum. Dynamic shock loads are frequent and machine may shake. Wear Material is very abrasive. Large scratch marks are visible and, or deform metal. Works within heaps of rock with occasional un-shot rock and rock boulders. Soil Granite, basalt, quartz sand, compact and sticky clay.	

Bucket Line-up

Category	Shape	Capacity (m ³)	Width (mm)		Weight* (kg)	Tooth Quantity	Boom + Arm (m)			Tooth Type
			With Side Shrouds, Side Cutters	Without Side Shrouds, Side Cutters			7.1 + 3.4	6.7 + 2.4 SE Spec.	6.7 + 2.9 SE Spec.	
GP	New shape bucket	3.10	2050	1915	2310	6	□	×	×	HP
		3.70	1840	1705	2390	5	×	×	□	HP
		4.00	1960	1825	2520	5	×	□	×	HP
HD	New shape bucket	2.50	1910	1910	2410	5	○	×	×	HP
		3.00	1720	1720	2530	5	×	×	○	HP
		3.50	1910	1910	2720	5	×	○	×	HP

* With side shrouds, side cutters ○: Material density up to 1.8 t/m³ □: Material density up to 1.5 t/m³ ×: Not usable

KOMATSU TOTAL SUPPORT



Komatsu Total Support

Komatsu Distributer is ready to provide variety of support before and after procuring machine to keep customers machine available and minimize operation cost.

Fleet recommendation

Komatsu Distributer can study customer job site and provide the most optimum fleet recommendation with detailed information to meet all of your application needs when you are considering to buy new machines or to replace the existing ones from Komatsu.

Product support

Komatsu Distributer secure the quality of machine by offering quality repair and maintenance services to the customer using Komatsu developed programs.

- Preventive Maintenance (PM) Clinic
- Komatsu Oil and Wear Analysis (KOWA)
- Undercarriage inspection service, etc.

Genuine parts and genuine oil

Komatsu Distributer will promptly and smoothly offer genuine parts and genuine oil guaranteed quality to various jobsites. Genuine oil is developed by Komatsu so that it is best matched for our Komatsu engines and hydraulic components. It maximizes engine and hydraulic components performance and prolong life.

Service contract

Komatsu Distributer offers several service package of repair and maintenance for a contracted period with optimum cost. Customer can be "worry-free" by trusting Komatsu Distributer skilled service.

Operator training

Komatsu Distributer can provide excellent operator training which enables them to operate machine safely & efficiently and to maintain machine properly.

SPECIFICATIONS



ENGINE

EU Stage 2 emission equivalent.

Model Komatsu SAA6D125E-5
 Type Water-cooled, 4-cycle, direct injection
 Aspiration Turbocharged, aftercooled
 Number of cylinders 6
 Bore/stroke 125 mm/150 mm
 Piston displacement 11.04 L
 Horsepower:
 SAE J1995 Gross 270 kW 362 HP
 ISO 9249 / SAE J1349 Net 269 kW 360 HP
 Rated rpm 1900 min⁻¹
 Fan drive method for radiator cooling Mechanical with viscous fan clutch
 Governor All-speed control, electronic



HYDRAULICS

Type HydraMind (Hydraulic Mechanical Intelligence New Design) system, closed-center system with load sensing valves and pressure compensated valves
 Number of selectable working modes 6
 Main pump:
 Type Variable displacement piston type
 Pumps for Boom, arm, bucket, swing, and travel circuits
 Maximum flow 690 L/min
 Supply for control circuit Self-reducing valve
 Hydraulic motors:
 Travel 2 x axial piston motors with parking brake
 Swing 1 x axial piston motor with swing holding brake
 Relief valve setting:
 Implement circuits 37.3 MPa 380 kgf/cm²
 Travel circuit 37.3 MPa 380 kgf/cm²
 Swing circuit 27.9 MPa 285 kgf/cm²
 Pilot circuit 3.2 MPa 33 kgf/cm²
 Hydraulic cylinders (Number of cylinders – bore x stroke x rod diameter) :
 Boom 2–170 mm x 1570 mm x 115 mm
 Arm
 Std 1–185 mm x 1985 mm x 130 mm
 SE 1–185 mm x 1800 mm x 130 mm
 Bucket
 Std 1–160 mm x 1450 mm x 115 mm
 SE 1–185 mm x 1350 mm x 130 mm



DRIVES AND BRAKES

Steering control Two levers with pedals
 Drive method Hydrostatic
 Maximum drawbar pull 329 kN 33550 kg
 Gradeability 70%, 35°
 Maximum travel speed: High 5.5 km/h
 (Auto-shift) Mid 4.2 km/h
 (Auto-shift) Low 3.0 km/h
 Service brake/parking brake Hydraulic lock/mechanical disc brake



SWING SYSTEM

Drive method Hydrostatic
 Swing reduction Planetary gear
 Swing circle lubrication Grease-bathed
 Service brake Hydraulic lock
 Holding brake/Swing lock Mechanical disc brake
 Swing speed 9.1 min⁻¹



UNDERCARRIAGE

Center frame X-frame
 Track frame Box-section
 Seal of track Sealed track
 Track adjuster Hydraulic
 Number of shoes (Each side) 49
 Number of carrier rollers (Each side) 2
 Number of track rollers (Each side) 8



COOLANT AND LUBRICANT CAPACITY (REFILLING)

Fuel tank 640 L
 Coolant 45.0 L
 Engine 37.0 L
 Final drive (Each side) 9.0 L
 Swing drive 17.0 L
 Hydraulic tank 279 L



OPERATING WEIGHT (APPROXIMATE)

Operating weight including one-piece boom, arm, ISO 7451 heaped backhoe bucket, rated capacity of lubricants, coolant, full fuel tank, operator, and standard equipment.

Shoes	PC500LC-10R	
	Boom: 7060 mm Arm: 3380 mm Bucket: 2.50 m ³	
	Operating Weight	Ground Pressure
600 mm	49500 kg	86.5 kPa 0.88 kgf/cm ²
700 mm	50000 kg	74.9 kPa 0.76 kgf/cm ²
800 mm	50500 kg	66.2 kPa 0.68 kgf/cm ²
900 mm	51100 kg	59.5 kPa 0.61 kgf/cm ²
600 mm (Double)	49600 kg	86.6 kPa 0.88 kgf/cm ²

Shoes	PC500LC-10R SE Spec.	
	Boom: 6670 mm Arm: 2400 mm Bucket: 4.00 m ³	
	Operating Weight	Ground Pressure
600 mm	49400 kg	86.3 kPa 0.88 kgf/cm ²
700 mm	49900 kg	74.7 kPa 0.76 kgf/cm ²
800 mm	50400 kg	66.0 kPa 0.67 kgf/cm ²
900 mm	51000 kg	59.4 kPa 0.61 kgf/cm ²
600 mm (Double)	49500 kg	86.5 kPa 0.88 kgf/cm ²

Shoes	PC500LC-10R SE Spec.	
	Boom: 6670 mm Arm: 2900 mm Bucket: 3.70 m ³	
	Operating Weight	Ground Pressure
600 mm	49700 kg	86.8 kPa 0.89 kgf/cm ²
700 mm	50200 kg	75.1 kPa 0.77 kgf/cm ²
800 mm	50700 kg	66.4 kPa 0.68 kgf/cm ²
900 mm	51300 kg	59.7 kPa 0.61 kgf/cm ²
600 mm (Double)	49800 kg	87.0 kPa 0.89 kgf/cm ²



DIMENSIONS & WORKING RANGE

Model		PC500LC-10R	PC500LC-10R SE Spec.	
Boom Length		7060 mm	6670 mm	6670 mm
Arm Length		3380 mm	2400 mm	2900 mm
A	Overall length	12260 mm	11945 mm	11855 mm
B	Length on ground (Transport)	6655 mm	8095 mm	7835 mm
C	Overall height (To top of boom)*	3990 mm	3980 mm	4220 mm
D	Overall width		3580 mm	
E	Overall height (To top of cab)*		3360 mm	
F	Overall height (To top of handrail)*		3460 mm	
G	Ground clearance, counterweight		1385 mm	
H	Ground clearance (Minimum)		570 mm	
I	Tail swing radius		3765 mm	
J	Track length on ground		4350 mm	
K	Track length		5385 mm	
L	Track gauge		2740 mm	
M	Width of crawler		3340 mm	
N	Shoe width		600 mm	
O	Grouser height		37 mm	
P	Machine height to top engine cover		3110 mm	
Q	Machine upper width		3520 mm	
R	Distance, swing center to rear end		3725 mm	
S	Max. digging height	10885 mm	10200 mm	10225 mm
T	Max. dumping height	7650 mm	6675 mm	6750 mm
U	Max. digging depth	7695 mm	6640 mm	7150 mm
V	Max. vertical wall digging depth	6335 mm	2495 mm	2725 mm
W	Max. digging depth of cut for 2440 mm level	7560 mm	6480 mm	7000 mm
X	Max. digging reach	11985 mm	10945 mm	11350 mm
Y	Max. digging reach at ground level	11760 mm	10720 mm	11135 mm
Z	Min. swing radius	5050 mm	4720 mm	4685 mm
SAE 1179 Rating	Bucket digging force at power max.	267 kN 27200 kgf	304 kN 31000 kgf	304 kN 31000 kgf
	Arm crowd force at power max.	228 kN 23300 kgf	262 kN 26700 kgf	244 kN 24900 kgf
ISO 6015 Rating	Bucket digging force at power max.	303 kN 30900 kgf	339 kN 34600 kgf	339 kN 34600 kgf
	Arm crowd force at power max.	235 kN 24000 kgf	273 kN 27800 kgf	251 kN 25600 kgf

* Including grouser height

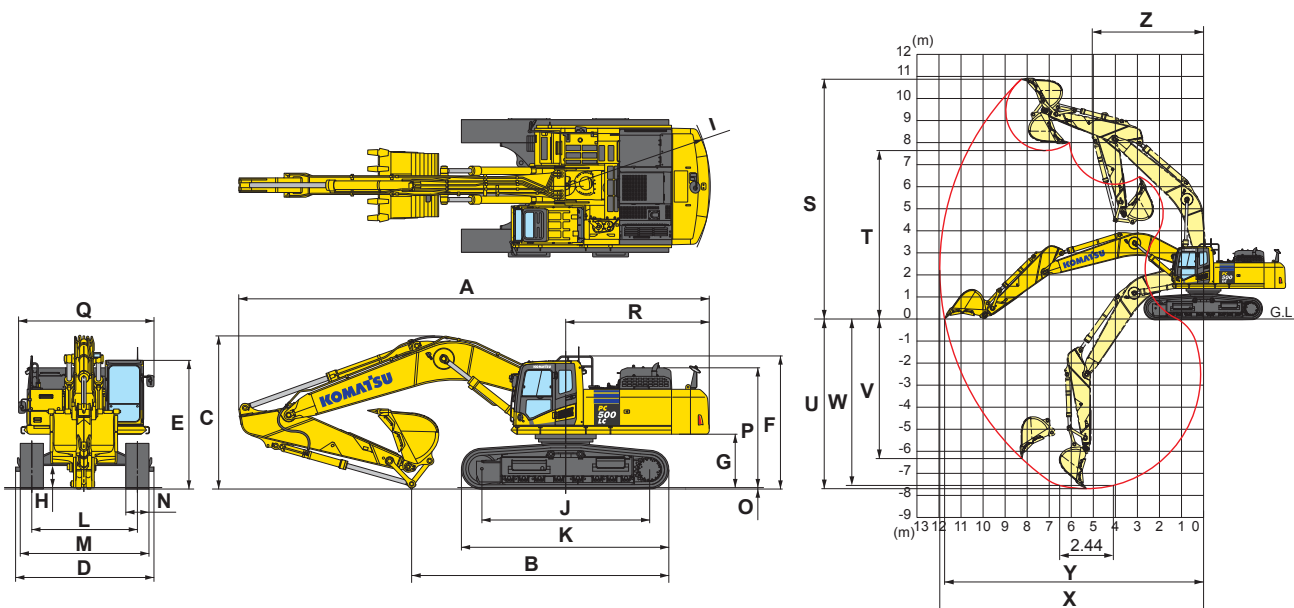



LIFTING CAPACITY WITH LIFTING MODE

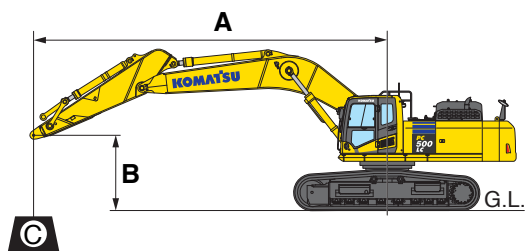

PC500LC-10R

- A: Reach from swing center
- B: Arm top pin height
- C: Lifting capacity
- Cf: Rating over front
- Cs: Rating over side
- ⊗: Rating at maximum reach

Conditions:

- 7060 mm one-piece boom
- 3380 mm arm
- Without bucket

PC500LC-10R		Arm: 3380 mm		Without bucket		Shoe: 600 mm triple grouser							
B	A	⊗ MAX		9.0 m		7.5 m		6.0 m		4.5 m		3.0 m	
		Cf	Cs	Cf	Cs	Cf	Cs	Cf	Cs	Cf	Cs	Cf	Cs
6.0 m		*7150 kg	*7150 kg	*11250 kg	8130 kg	*12640 kg	10990 kg						
4.5 m		*7260 kg	6710 kg	*12200 kg	7920 kg	*13720 kg	10540 kg	*16340 kg	14750 kg	*21500 kg	*21500 kg		
3.0 m		*7570 kg	6330 kg	12050 kg	7660 kg	*14920 kg	10030 kg	*18570 kg	13800 kg	*26090 kg	20720 kg		
1.5 m		*8120 kg	6200 kg	11780 kg	7410 kg	15480 kg	9590 kg	*20210 kg	13050 kg	*19930 kg	19520 kg		
0 m		*9010 kg	6320 kg	11580 kg	7230 kg	15140 kg	9290 kg	*20850 kg	12620 kg	*23050 kg	19150 kg		
-1.5 m		*10450 kg	6740 kg	11510 kg	7160 kg	14980 kg	9150 kg	*20450 kg	12460 kg	*26730 kg	19130 kg	*17090 kg	*17090 kg
-3.0 m		*12130 kg	7610 kg			*14970 kg	9180 kg	*18940 kg	12520 kg	*24210 kg	19340 kg	*26380 kg	*26380 kg
-4.5 m		*11730 kg	9410 kg			*11860 kg	9480 kg	*15930 kg	12800 kg	*20150 kg	19790 kg	*25160 kg	*25160 kg

PC500LC-10R		Arm: 3380 mm		Without bucket		Shoe: 700 mm triple grouser							
B	A	⊗ MAX		9.0 m		7.5 m		6.0 m		4.5 m		3.0 m	
		Cf	Cs	Cf	Cs	Cf	Cs	Cf	Cs	Cf	Cs	Cf	Cs
6.0 m		*7150 kg	*7150 kg	*11250 kg	8150 kg	*12640 kg	11010 kg						
4.5 m		*7260 kg	6730 kg	*12200 kg	7940 kg	*13720 kg	10560 kg	*16340 kg	14780 kg	*21500 kg	*21500 kg		
3.0 m		*7570 kg	6350 kg	12090 kg	7680 kg	*14920 kg	10060 kg	*18570 kg	13830 kg	*26090 kg	20760 kg		
1.5 m		*8120 kg	6220 kg	11820 kg	7420 kg	15530 kg	9620 kg	*20210 kg	13080 kg	*19930 kg	19570 kg		
0 m		*9010 kg	6340 kg	11620 kg	7240 kg	15190 kg	9310 kg	*20850 kg	12650 kg	*23050 kg	19190 kg		
-1.5 m		*10450 kg	6750 kg	11550 kg	7180 kg	15030 kg	9170 kg	*20450 kg	12490 kg	*26730 kg	19180 kg	*17090 kg	*17090 kg
-3.0 m		*12130 kg	7630 kg			*14970 kg	9200 kg	*18940 kg	12550 kg	*24210 kg	19390 kg	*26380 kg	*26380 kg
-4.5 m		*11730 kg	9440 kg			*11860 kg	9500 kg	*15930 kg	12830 kg	*20150 kg	19830 kg	*25160 kg	*25160 kg

PC500LC-10R		Arm: 3380 mm		Without bucket		Shoe: 800 mm triple grouser							
B	A	⊗ MAX		9.0 m		7.5 m		6.0 m		4.5 m		3.0 m	
		Cf	Cs	Cf	Cs	Cf	Cs	Cf	Cs	Cf	Cs	Cf	Cs
6.0 m		*7150 kg	*7150 kg	*11250 kg	8220 kg	*12640 kg	11100 kg						
4.5 m		*7260 kg	6800 kg	*12200 kg	8020 kg	*13720 kg	10650 kg	*16340 kg	14900 kg	*21500 kg	*21500 kg		
3.0 m		*7570 kg	6410 kg	12210 kg	7750 kg	*14920 kg	10150 kg	*18570 kg	13960 kg	*26090 kg	20950 kg		
1.5 m		*8120 kg	6280 kg	11940 kg	7500 kg	15680 kg	9710 kg	*20210 kg	13210 kg	*19930 kg	19750 kg		
0 m		*9010 kg	6400 kg	11740 kg	7320 kg	15340 kg	9400 kg	*20850 kg	12770 kg	*23050 kg	19370 kg		
-1.5 m		*10450 kg	6820 kg	11670 kg	7250 kg	15180 kg	9260 kg	*20450 kg	12610 kg	*26730 kg	19360 kg	*17090 kg	*17090 kg
-3.0 m		*12130 kg	7710 kg			*14970 kg	9300 kg	*18940 kg	12670 kg	*24210 kg	19570 kg	*26380 kg	*26380 kg
-4.5 m		*11730 kg	9530 kg			*11860 kg	9590 kg	*15930 kg	12960 kg	*20150 kg	20010 kg	*25160 kg	*25160 kg

PC500LC-10R		Arm: 3380 mm		Without bucket		Shoe: 900 mm triple grouser							
B	A	⊗ MAX		9.0 m		7.5 m		6.0 m		4.5 m		3.0 m	
		Cf	Cs	Cf	Cs	Cf	Cs	Cf	Cs	Cf	Cs	Cf	Cs
6.0 m		*7150 kg	*7150 kg	*11250 kg	8300 kg	*12640 kg	11190 kg						
4.5 m		*7260 kg	6860 kg	*12200 kg	8090 kg	*13720 kg	10740 kg	*16340 kg	15020 kg	*21500 kg	*21500 kg		
3.0 m		*7570 kg	6470 kg	12330 kg	7820 kg	*14920 kg	10240 kg	*18570 kg	14080 kg	*26090 kg	21130 kg		
1.5 m		*8120 kg	6340 kg	12050 kg	7570 kg	15630 kg	9800 kg	*20210 kg	13330 kg	*19930 kg	19930 kg		
0 m		*9010 kg	6470 kg	11850 kg	7390 kg	15490 kg	9490 kg	*20850 kg	12890 kg	*23050 kg	19550 kg		
-1.5 m		*10450 kg	6890 kg	11780 kg	7330 kg	15330 kg	9350 kg	*20450 kg	12730 kg	*26730 kg	19540 kg	*17090 kg	*17090 kg
-3.0 m		*12130 kg	7780 kg			*14970 kg	9390 kg	*18940 kg	12790 kg	*24210 kg	19750 kg	*26380 kg	*26380 kg
-4.5 m		*11730 kg	9620 kg			*11860 kg	9680 kg	*15930 kg	13080 kg	*20150 kg	*20150 kg	*25160 kg	*25160 kg

* Load is limited by hydraulic capacity rather than tipping. Ratings are based on ISO standard No.10567. Rated loads do not exceed 87% of hydraulic lift capacity or 75% of tipping load.

PC500LC-10R



LIFTING CAPACITY WITH LIFTING MODE

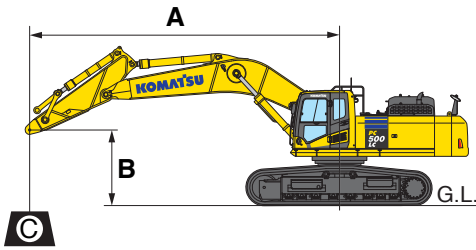

PC500LC-10R SE Spec.

- A: Reach from swing center
- B: Arm top pin height
- C: Lifting capacity
- Cf: Rating over front
- Cs: Rating over side
- ⊗: Rating at maximum reach

- Conditions:
- 6670 mm one-piece boom
 - 2400 mm arm
 - Without bucket

PC500LC-10R SE Spec.		Arm: 2400 mm		Without bucket		Shoe: 600 mm triple grouser							
B	A	⊗ MAX		9.0 m		7.5 m		6.0 m		4.5 m		3.0 m	
		Cf	Cs	Cf	Cs	Cf	Cs	Cf	Cs	Cf	Cs	Cf	Cs
6.0 m		*14320 kg	9530 kg			*14670 kg	10620 kg	*16590 kg	15110 kg				
4.5 m		13130 kg	8380 kg			*15360 kg	10290 kg	*18400 kg	14340 kg				
3.0 m		12320 kg	7810 kg			15780 kg	9890 kg	*20200 kg	13560 kg				
1.5 m		12160 kg	7660 kg			15410 kg	9570 kg	*21190 kg	13000 kg				
0 m		12620 kg	7910 kg			15210 kg	9390 kg	*20990 kg	12750 kg				
-1.5 m		13950 kg	8680 kg			15200 kg	9380 kg	*19550 kg	12730 kg	*24530 kg	19660 kg		
-3.0 m		*13310 kg	10440 kg					*16490 kg	12960 kg	*20530 kg	20000 kg	*22950 kg	*22950 kg
-4.5 m													

PC500LC-10R SE Spec.		Arm: 2400 mm		Without bucket		Shoe: 700 mm triple grouser							
B	A	⊗ MAX		9.0 m		7.5 m		6.0 m		4.5 m		3.0 m	
		Cf	Cs	Cf	Cs	Cf	Cs	Cf	Cs	Cf	Cs	Cf	Cs
6.0 m		*14320 kg	9610 kg			*14670 kg	10710 kg	*16560 kg	15240 kg				
4.5 m		13250 kg	8460 kg			*15360 kg	10380 kg	*18400 kg	14470 kg				
3.0 m		12440 kg	7890 kg			15930 kg	9990 kg	*20200 kg	13690 kg				
1.5 m		12280 kg	7740 kg			15560 kg	9670 kg	*21190 kg	13130 kg				
0 m		12750 kg	7990 kg			15360 kg	9480 kg	*20990 kg	12870 kg				
-1.5 m		*13960 kg	8770 kg			*15300 kg	9480 kg	*19550 kg	12860 kg	*24530 kg	19850 kg		
-3.0 m		*13310 kg	10540 kg					*16490 kg	13080 kg	*20530 kg	20190 kg	*22950 kg	*22950 kg
-4.5 m													

PC500LC-10R SE Spec.		Arm: 2400 mm		Without bucket		Shoe: 800 mm triple grouser							
B	A	⊗ MAX		9.0 m		7.5 m		6.0 m		4.5 m		3.0 m	
		Cf	Cs	Cf	Cs	Cf	Cs	Cf	Cs	Cf	Cs	Cf	Cs
6.0 m		*14320 kg	9700 kg			*14670 kg	10810 kg	*16590 kg	15360 kg				
4.5 m		13380 kg	8540 kg			*15360 kg	10470 kg	*18400 kg	14590 kg				
3.0 m		12560 kg	7970 kg			16080 kg	10080 kg	*20200 kg	13810 kg				
1.5 m		12400 kg	7820 kg			15720 kg	9760 kg	*21190 kg	13250 kg				
0 m		12880 kg	8070 kg			15510 kg	9570 kg	*20990 kg	13000 kg				
-1.5 m		*13960 kg	8860 kg			*15300 kg	9570 kg	*19550 kg	12980 kg	*24530 kg	20030 kg		
-3.0 m		*13310 kg	10640 kg					*16490 kg	13210 kg	*20530 kg	20370 kg	*22950 kg	*22950 kg
-4.5 m													

PC500LC-10R SE Spec.		Arm: 2400 mm		Without bucket		Shoe: 900 mm triple grouser							
B	A	⊗ MAX		9.0 m		7.5 m		6.0 m		4.5 m		3.0 m	
		Cf	Cs	Cf	Cs	Cf	Cs	Cf	Cs	Cf	Cs	Cf	Cs
6.0 m		*14320 kg	9780 kg			*14670 kg	10900 kg	*16590 kg	15480 kg				
4.5 m		13510 kg	8620 kg			*15360 kg	10560 kg	*18400 kg	14710 kg				
3.0 m		12680 kg	8040 kg			*16190 kg	10170 kg	*20200 kg	13930 kg				
1.5 m		12520 kg	7890 kg			15870 kg	9850 kg	*21190 kg	13370 kg				
0 m		13000 kg	8150 kg			15660 kg	9660 kg	*20990 kg	13120 kg				
-1.5 m		*13960 kg	8940 kg			*15300 kg	9660 kg	*19550 kg	13100 kg	*24530 kg	20210 kg		
-3.0 m		*13310 kg	10740 kg					*16490 kg	13330 kg	*20530 kg	*20530 kg	*22950 kg	*22950 kg
-4.5 m													

* Load is limited by hydraulic capacity rather than tipping. Ratings are based on ISO standard No. 10567. Rated loads do not exceed 87% of hydraulic lift capacity or 75% of tipping load.



LIFTING CAPACITY WITH LIFTING MODE

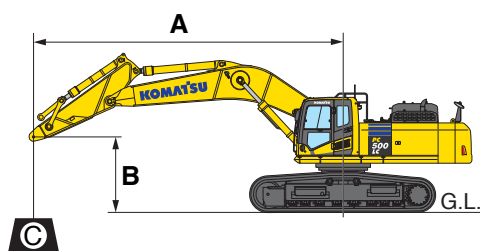

PC500LC-10R SE Spec.

- A: Reach from swing center
- B: Arm top pin height
- C: Lifting capacity
- Cf: Rating over front
- Cs: Rating over side
- ⊗: Rating at maximum reach

- Conditions:
- 6670 mm one-piece boom
 - 2900 mm arm
 - Without bucket

PC500LC-10R SE Spec.		Arm: 2900 mm		Without bucket		Shoe: 600 mm triple grouser							
B	A	⊗ MAX		9.0 m		7.5 m		6.0 m		4.5 m		3.0 m	
		Cf	Cs	Cf	Cs	Cf	Cs	Cf	Cs	Cf	Cs	Cf	Cs
6.0 m		*13210 kg	8720 kg			*13810 kg	10660 kg	*15530 kg	15250 kg				
4.5 m		12130 kg	7720 kg			*14650 kg	10270 kg	*17410 kg	14430 kg	*22870 kg	22390 kg		
3.0 m		11410 kg	7210 kg	11840 kg	7470 kg	*15610 kg	9830 kg	*19380 kg	13570 kg				
1.5 m		11240 kg	7050 kg	11630 kg	7280 kg	15300 kg	9450 kg	*20690 kg	12910 kg				
0 m		11600 kg	7230 kg			15020 kg	9210 kg	*20900 kg	12550 kg	*24620 kg	19170 kg		
-1.5 m		12660 kg	7850 kg			14950 kg	9140 kg	*19910 kg	12460 kg	*25680 kg	19220 kg		
-3.0 m		*13050 kg	9220 kg			*13210 kg	9300 kg	*17480 kg	12600 kg	*22140 kg	19510 kg	*26930 kg	*26930 kg
-4.5 m		*11780 kg	*11780 kg					*12460 kg	*12460 kg	*16350 kg	*16350 kg		

PC500LC-10R SE Spec.		Arm: 2900 mm		Without bucket		Shoe: 700 mm triple grouser							
B	A	⊗ MAX		9.0 m		7.5 m		6.0 m		4.5 m		3.0 m	
		Cf	Cs	Cf	Cs	Cf	Cs	Cf	Cs	Cf	Cs	Cf	Cs
6.0 m		*13210 kg	8800 kg			*13810 kg	10750 kg	*15530 kg	15370 kg				
4.5 m		12250 kg	7790 kg			*14650 kg	10370 kg	*17410 kg	14560 kg	*22870 kg	22580 kg		
3.0 m		11530 kg	7280 kg	11960 kg	7550 kg	*15610 kg	9920 kg	*19380 kg	13690 kg				
1.5 m		11360 kg	7120 kg	11750 kg	7360 kg	15450 kg	9540 kg	*20690 kg	13030 kg				
0 m		11720 kg	7310 kg			15180 kg	9300 kg	*20900 kg	12670 kg	*24620 kg	19350 kg		
-1.5 m		12790 kg	7930 kg			15100 kg	9230 kg	*19910 kg	12580 kg	*25680 kg	19400 kg		
-3.0 m		*13050 kg	9310 kg			*13210 kg	9390 kg	*17480 kg	12730 kg	*22140 kg	19690 kg	*26930 kg	*26930 kg
-4.5 m		*11780 kg	*11780 kg					*12460 kg	*12460 kg	*16350 kg	*16350 kg		

PC500LC-10R SE Spec.		Arm: 2900 mm		Without bucket		Shoe: 800 mm triple grouser							
B	A	⊗ MAX		9.0 m		7.5 m		6.0 m		4.5 m		3.0 m	
		Cf	Cs	Cf	Cs	Cf	Cs	Cf	Cs	Cf	Cs	Cf	Cs
6.0 m		*13210 kg	8880 kg			*13810 kg	10840 kg	*15530 kg	15490 kg				
4.5 m		12370 kg	7870 kg			*14650 kg	10460 kg	*17410 kg	14680 kg	*22870 kg	22760 kg		
3.0 m		11640 kg	7350 kg	12080 kg	7620 kg	*15610 kg	10020 kg	*19380 kg	13820 kg				
1.5 m		11470 kg	7190 kg	11870 kg	7430 kg	15610 kg	9630 kg	*20690 kg	13150 kg				
0 m		11840 kg	7380 kg			15330 kg	9390 kg	*20900 kg	12790 kg	*24620 kg	19540 kg		
-1.5 m		12920 kg	8010 kg			15250 kg	9320 kg	*19910 kg	12700 kg	*25680 kg	19590 kg		
-3.0 m		*13050 kg	9410 kg			*13210 kg	9480 kg	*17480 kg	12850 kg	*22140 kg	19870 kg	*26930 kg	*26930 kg
-4.5 m		*11780 kg	*11780 kg					*12460 kg	*12460 kg	*16350 kg	*16350 kg		

PC500LC-10R SE Spec.		Arm: 2900 mm		Without bucket		Shoe: 900 mm triple grouser							
B	A	⊗ MAX		9.0 m		7.5 m		6.0 m		4.5 m		3.0 m	
		Cf	Cs	Cf	Cs	Cf	Cs	Cf	Cs	Cf	Cs	Cf	Cs
6.0 m		*13210 kg	8950 kg			*13810 kg	10930 kg	*15530 kg	*15530 kg				
4.5 m		12490 kg	7940 kg			*14650 kg	10550 kg	*17410 kg	14800 kg	*22870 kg	*22870 kg		
3.0 m		11760 kg	7420 kg	12190 kg	7690 kg	*15610 kg	10110 kg	*19380 kg	13940 kg				
1.5 m		11590 kg	7260 kg	11980 kg	7500 kg	15760 kg	9720 kg	*20690 kg	13270 kg				
0 m		11960 kg	7450 kg			15480 kg	9480 kg	*20900 kg	12910 kg	*24620 kg	19720 kg		
-1.5 m		13050 kg	8090 kg			15400 kg	9410 kg	*19910 kg	12820 kg	*25680 kg	19770 kg		
-3.0 m		*13050 kg	9500 kg			*13210 kg	9570 kg	*17480 kg	12970 kg	*22140 kg	20050 kg	*26930 kg	*26930 kg
-4.5 m		*11780 kg	*11780 kg					*12460 kg	*12460 kg	*16350 kg	*16350 kg		

* Load is limited by hydraulic capacity rather than tipping. Ratings are based on ISO standard No.10567. Rated loads do not exceed 87% of hydraulic lift capacity or 75% of tipping load.

PC500LC-10R

Major Component Weights

Items		Weight for a Machine (kg)
Boom (Incl. Piping, Pins, Arm Cylinder)	7.1 m	4480
	6.7 m	4410
Arm (Incl. Piping, Pins, Bucket Cylinder)	3.4 m	2740
	2.9 m	3000
	2.4 m	2660
Bucket (Without Linkage)	4.0 m ³ GP	2520
	3.7 m ³ GP	2390
	3.5 m ³ HD	2720
	3.1 m ³ GP	2310
	3.0 m ³ HD	2530
	2.5 m ³ HD	2410
Counterweight		10740
Undercarriage	LC	6560
Shoe Assembly (With Link)	600 mm Triple Grouser Shoes	5240
	700 mm Triple Grouser Shoes	5740
	800 mm Triple Grouser Shoes	6240
	900 mm Triple Grouser Shoes	6730
	600 mm Double Grouser Shoes	5360

Standard Specification:

Operating weight: PC500LC-10R: 49500 kg

Operating weight including below spec.

Boom: 7060 mm STD

Arm: 3380 mm STD

Bucket: 2.5 m³ GP

Shoe: 600 mm triple grouser

Rated capacity of lubricants, coolant, full fuel tank, 80 kg operator.



STANDARD EQUIPMENT

ENGINE

- Air pre-cleaner
- Automatic engine warm-up system
- Compliant bio diesel fuel
- Coolant filter
- Dry type air cleaner, double element
- Electric priming pump
- Engine, Komatsu SAA6D125E-5
- Engine overheat prevention system
- Fan clutch
- Fuel pre-filter (With water separator)
- Radiator and oil cooler dust proof net

ELECTRICAL SYSTEM

- Alternator, 24 V/60 A brushless
- Auto-decelerator
- Batteries, 2 X 12 V/140 Ah
- Battery disconnect switch with operation lamp
- Electric horn
- Starting motor, 24 V/11 kW
- Working light, 4 (Boom, RH and 2 on cab)

HYDRAULIC SYSTEM

- Arm holding valve
- Boom holding valve
- Clogging sensor for hydraulic oil return filter
- Inline filter
- Pilot filter
- Power maximizing system
- Pressure Proportional Control (PPC) hydraulic control system
- Two-mode setting for boom
- Working mode selection system

GUARDS AND COVERS

- Fan guard structure
- Heavy duty revolving frame undercover
- Revolving frame deck guard
- Track roller guards (Full length)

UNDERCARRIAGE

- Hydraulic track adjusters (Each side)
- Track frame undercover
- Track roller
 - 8 each side
- Track shoe
 - 600 mm triple grouser

OPERATOR ENVIRONMENT

- A/C with defroster
- AUX equipped with radio
- Large multi-lingual and high resolution LCD monitor
- Lock lever
- Operator protective top guard (OPG), level 1 (ISO 10262)
- Rear view mirrors (RH, LH, sidewise, rear)
- Seat belt, retractable
- Sun roller blind
- Suspension seat

OTHER EQUIPMENT

- Blow-by sensor
- Counterweight, 10740 kg
- KOMTRAX
- Rear reflector
- Slip-resistant plates
- Travel alarm



OPTIONAL EQUIPMENT

ELECTRICAL SYSTEM

- Working lights (1 on counterweight)

HYDRAULIC SYSTEM

- Attachment piping
- Clogging sensor for breaker return filter
- Service valve

GUARDS AND COVERS

- Additional handrail
- Bolt-on top guard, OPG top guard level 2 (ISO 10262)
- Cab front guard
 - Full height guard, OPG level 1 (ISO 10262)
 - Full height guard, OPG level 2 (ISO 10262)
 - Half height guard

UNDERCARRIAGE

- Shoes, double grouser shoes
 - 600 mm
- Shoes, triple grouser shoes
 - 700 mm, 800 mm, 900 mm

OPERATOR ENVIRONMENT

- Cab accessories
 - Rain visor
 - Sun visor
- Rear view monitor system

WORK EQUIPMENT

- Arms
 - PC500LC-10R
 - 3380 mm arm assembly
 - PC500LC-10R SE spec.
 - 2400 mm SE arm assembly
 - 2900 mm SE arm assembly
- Booms (Backhoe)
 - PC500LC-10R
 - 7060 mm boom assembly
 - PC500LC-10R SE spec.
 - 6670 mm SE boom assembly

SERVICING EQUIPMENT

- Fuel refill pump
- Oil sampling port (Engine & hydraulic)
- Preventive Maintenance (PM) service-connector

Standard/option equipment may change. For more details, please consult your distributor.

